



Rise Together.

Spiral Conveyor

Custom-configured with the most sanitary, modular design elements for a variety of product applications.



Clean in place belt washer option shown



DESIGN INNOVATIONS

The redesigned custom-configured Spiral Conveyor incorporates the most sanitary designed elements including a patented monopiece cage bar for efficient cleaning and maintenance. Equipped with plastic modular belting using Intralox DirectDrive™ System technology, AMF's Spiral Conveyors are offered for a variety of product applications including intermediate dough proofing, product proofing, product cooling and product freezing. For better, faster decision making, AMF's Spiral Conveyor integrates the AMFConnect™ solution delivering real-time production line data and equipment status information.

SANITATION

Patented monopiece cage bar design offers efficient installation and improved access for cleaning and maintenance. Full wash-down construction meeting highest food processing standards.



AMF Patented Monopiece Cage Bar

CONTROL

Intralox DirectDrive™ System over an alternative Friction Drive eliminates product movement on the belt, minimizing potential jams or downstream process complications.

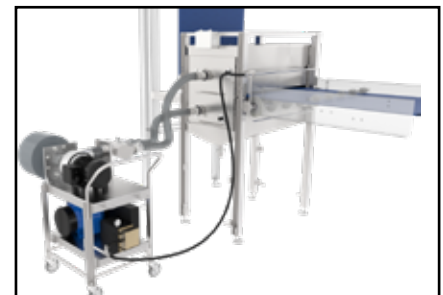

Optional Belt Washer & Dryer System

SIMPLICITY

AMF's proprietary AMFConnect™ data tracking and management solutions allow for real-time process adjustments.

QUALITY

AMF Spiral Conveyors are built with high quality select components for all motorization options, carrying belts and structural materials.

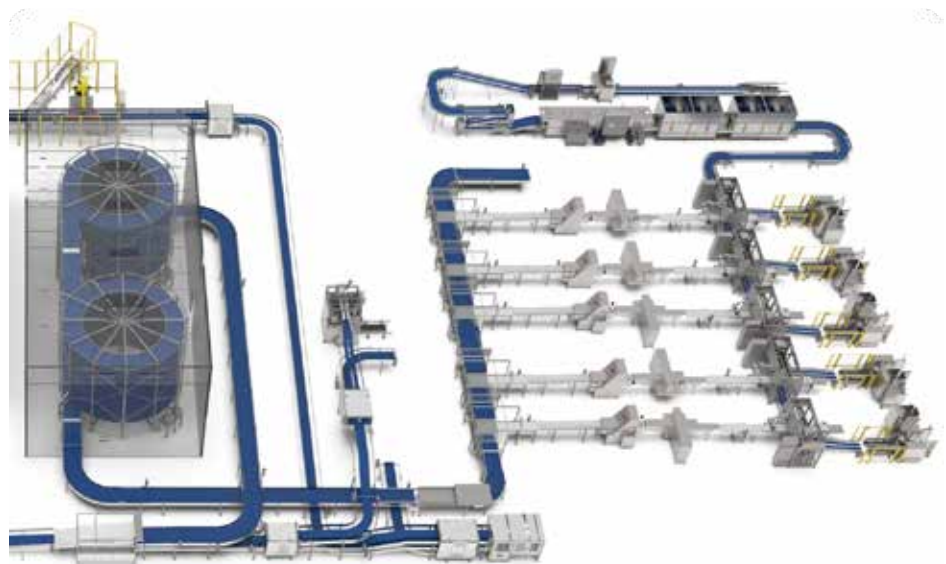

Designed With Sanitation In Mind

OTHER ADVANTAGES

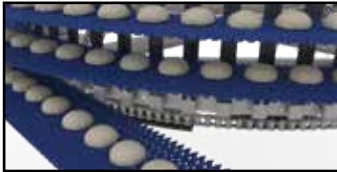

Dough Ball Intermediate Proofing

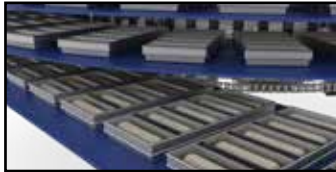

Product Proofing



Product Cooling

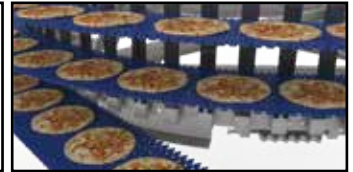

Product Freezing

- ▼ Custom-configured with quality materials and components to ensure high performance, longevity and minimal maintenance.
- ▼ Easy replacement, upper bearing without lubrication. Direct shaft motor mount and heavy-duty chain drive for improved reliability.
- ▼ Modular structure, cage drum, infeed and discharge conveyors allow fast installation and superior airflow with improved aerodynamic design.
- ▼ Exclusive motorized Arch Conveyor Belt Return system reduces belt tension and provides stable operation.
- ▼ Easy-to-operate, PLC with intuitive pushbutton controls.
- ▼ Wireless access to equipment performance data with real-time trend displays for historical data to prompting preventative maintenance.



Easily Replaced Upper Bearing



Monopiece Sanitary Cage Bar

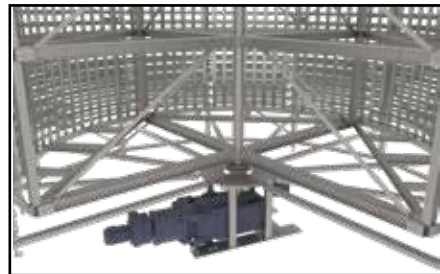

Open Drum for Easy Sanitation



Easy to Clean, Adjustable Columns



Motorized Arch Conveyor Belt Return System for all Configuration other than 0°S

SPECIFICATIONS

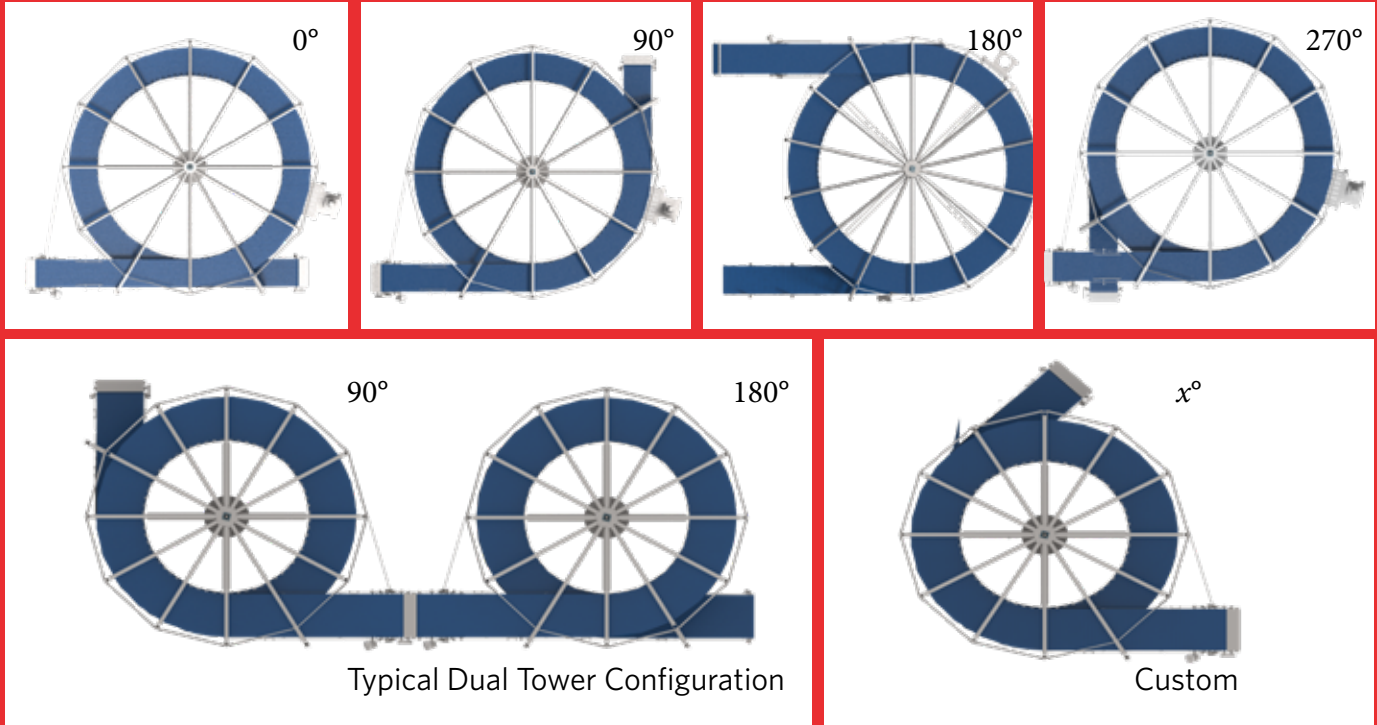

* See Belt Washer and Dryer brochure for more details.

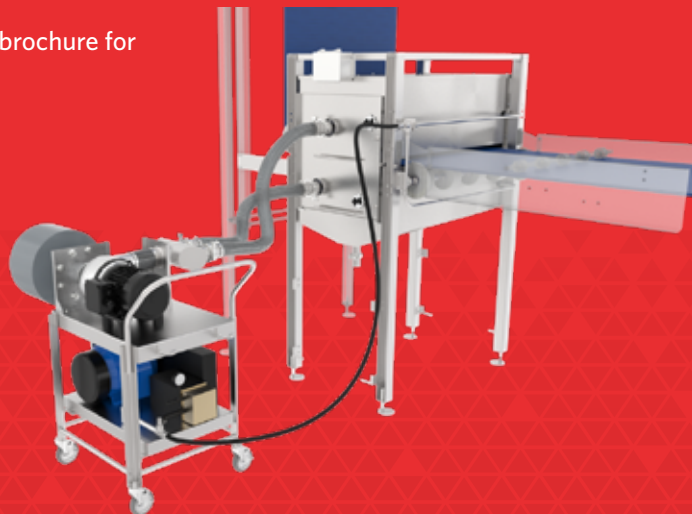

AMF IS A MARKEL FOOD GROUP COMPANY

AMF's focus on continuous improvement may result in changes to machinery specifications without notice.

08.01.19